

06/2013

Mod: NT42/G-VV

Production code: P011F03006 (IF42VS)



Diamond
catering equipment



KNEADING MACHINE



IF42VS-NT42/G-VV

IF53VS-NT53/G-VV

EXPLODED VIEW and SPARE PARTS LIST IF-VS ÷ IR-VS

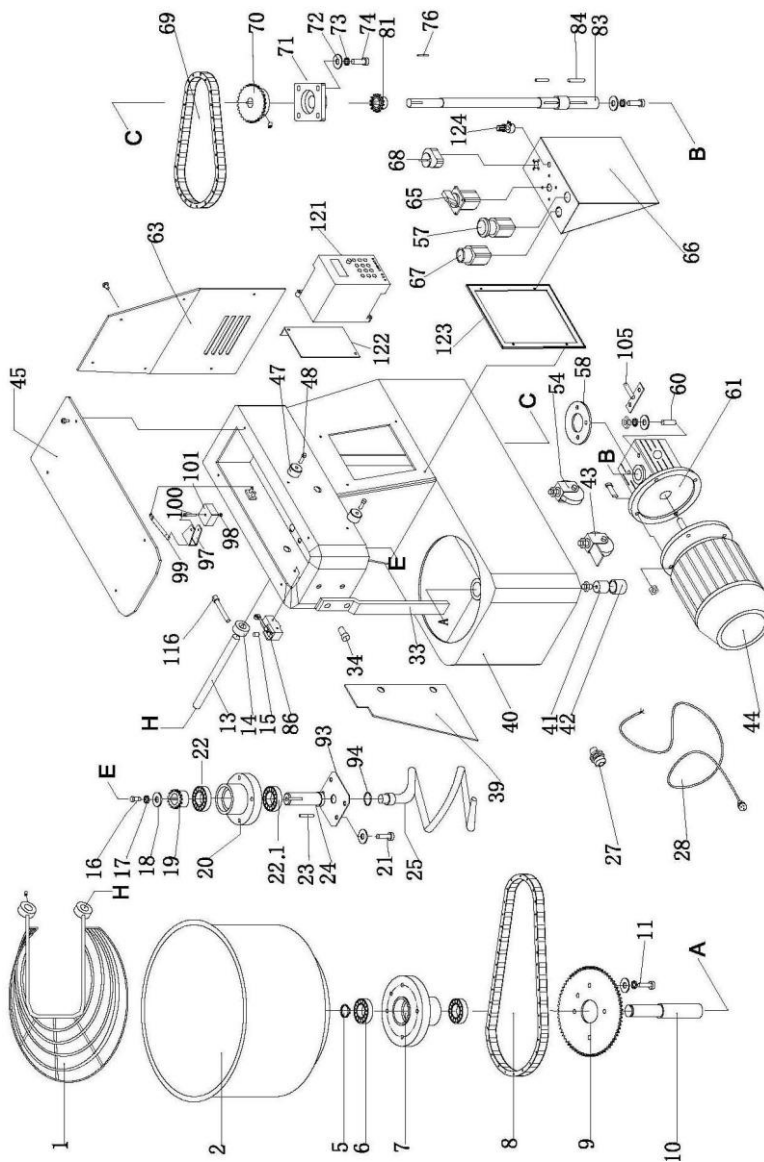

IF 17-22-33-42-53 VS

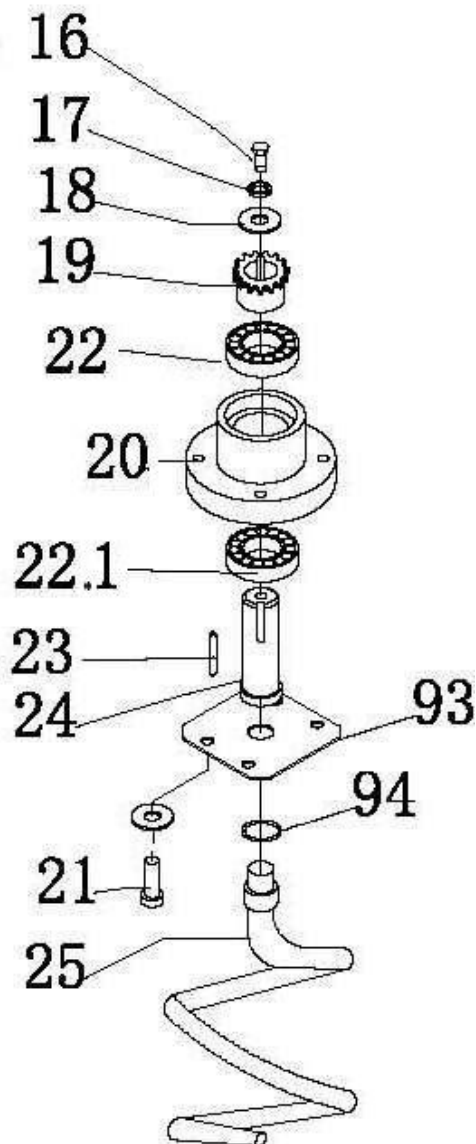

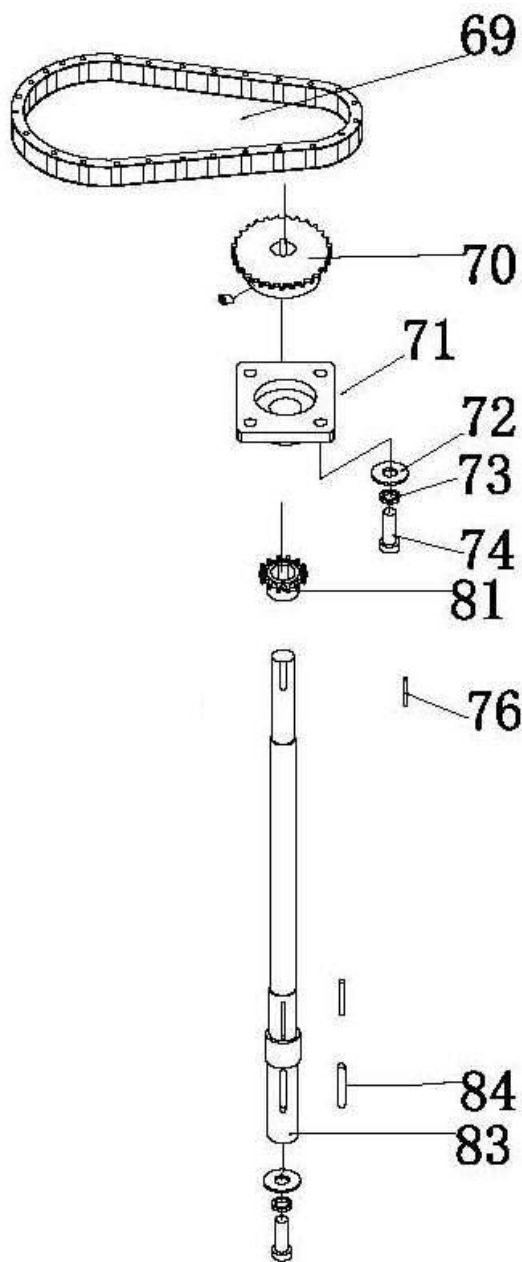

IF 17÷22÷33÷42÷53 VS

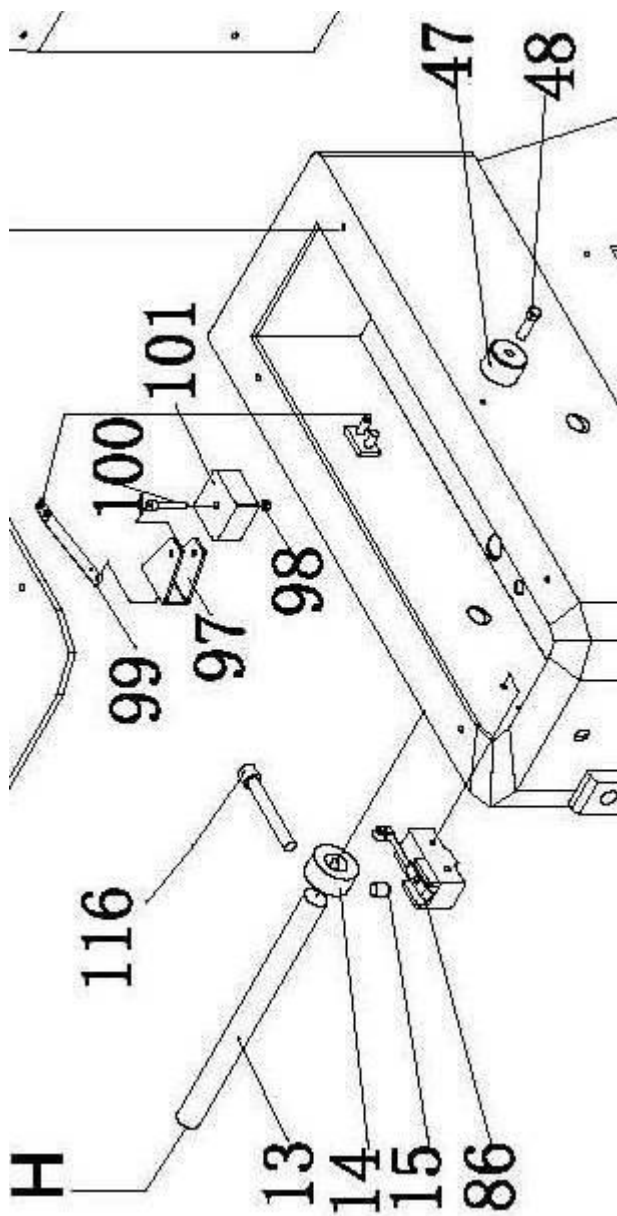

IF 17:22:33:42:53 VS

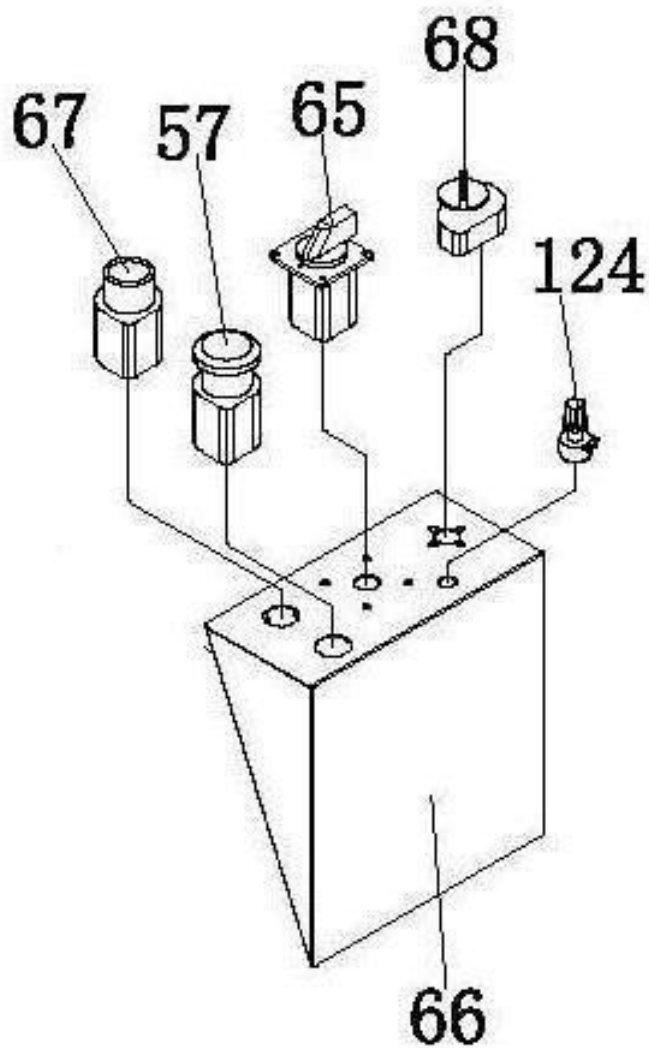

IF 17÷22÷33÷42÷53 VS ÷ IR 17÷22÷33÷42÷53 VS

	IF17 VS	IF22 VS	IF33 VS	IF42 VS	IF53 VS
POS.					
1	A96ZE00007	A96ZE00008	A96ZE00009	A96ZE00010	A96ZE00011
2	A96ZV00015	A96ZV00016	A96ZV00017	A96ZV00018	A96ZV00019
5	A96ZD00001	A96ZD00001	A96ZD00001	A96ZD00001	A96ZD00001
6	A89CK00010	A89CK00010	A89CK00010	A89CK00010	A89CK00010
7	A96ZV00025	A96ZV00025	A96ZV00025	A96ZV00025	A96ZV00025
8	S14MT67014	S14MT67014	S14MT67015	S14MT67015	S14MT67015
9	A96ZR00004	A96ZR00004	A96ZR00005	A96ZR00005	A96ZR00005
10	A96ZI00013	A96ZI00013	A96ZI00013	A96ZI00013	A96ZI00013
11	A86ME24115	A86ME24115	A86ME24115	A86ME24115	A86ME24115
13	A96ZI00014	A96ZI00014	S63FS67001	S63FS67001	S63FS67001
14	A96ZE00012	A96ZE00012	A96ZE00012	A96ZE00012	A96ZE00012
15	A86ME32013	A86ME32013	A86ME32013	A86ME32013	A86ME32013
16	A86ME24116	A86ME24116	A86ME24116	A86ME24116	A86ME24116
17	A86ME26024	A86ME26024	A86ME26024	A86ME26024	A86ME26024
18	A86ME26025	A86ME26025	A86ME26025	A86ME26025	A86ME26025
19	A96ZH00006	A96ZH00006	A96ZH00007	A96ZH00007	A96ZH00007
20	A96ZS00006	A96ZS00006	A96ZS00007	A96ZS00007	A96ZS00007
21	A86ME24114	A86ME24114	A86ME24114	A86ME24114	A86ME24114
22	A89CK00010	A89CK00010	A89CK00010	A89CK00010	A89CK00010
22.1	A89CK00010	A89CK00010	A89CK00011	A89CK00011	A89CK00011
23	A86ME36008	A86ME36008	A86ME36009	A86ME36009	A86ME36009
24	A96ZI00015	A96ZI00015	A96ZI00016	A96ZI00016	A96ZI00016
25	A96ZS00004	A96ZS00004	A96ZS00005	A96ZS00005	A96ZS00005
27	A96ZN00025	A96ZN00025	A96ZN00025	A96ZN00025	A96ZN00025
28	A96ZN00026	A96ZN00026	A96ZN00026	A96ZN00026	A96ZN00026
33	A96ZA00001	A96ZA00001	A96ZA00002	A96ZA00003	A96ZA00004
34	A86ME24117	A86ME24117	A86ME24117	A86ME24117	A86ME24117
39	A96ZB00006	A96ZB00006	A96ZB00007	A96ZB00007	A96ZB00007
40	-----	-----	-----	-----	-----
41	A96ZF00011	A96ZF00011	A96ZF00011	A96ZF00011	A96ZF00011
42	A96ZF00019	A96ZF00019	A96ZF00019	A96ZF00019	A96ZF00019
43	A96ZG00003	A96ZG00003	A96ZG00003	A96ZG00003	A96ZG00003
44	A87MR56010	A87MR56010	A96ZJ00024	A96ZJ00024	A96ZJ00024
45	A96ZC00002	A96ZC00002	A96ZC00004	A96ZC00004	A96ZC00004
47	A96ZD00002	A96ZD00002	A96ZD00002	A96ZD00002	A96ZD00002
48	A86ME24119	A86ME24119	A86ME24119	A86ME24119	A86ME24119
54	A96ZG00004	A96ZG00004	A96ZG00004	A96ZG00004	A96ZG00004
55	A96ZN00064	A96ZN00064	A96ZN00064	A96ZN00064	A96ZN00064
57	A96ZN00031	A96ZN00031	A96ZN00031	A96ZN00031	A96ZN00031
58	A96ZL00010	A96ZL00010	A96ZL00018	A96ZL00011	A96ZL00011
60	A86ME32014	A86ME32014	A86ME32014	A86ME32014	A86ME32014
61	A96ZL00008	A96ZL00008	A96ZL00015	A96ZL00015	A96ZL00015
63	A96ZC00007	A96ZC00007	A96ZC00008	A96ZC00008	A96ZC00008
64	A96ZN00040	A96ZN00040	A96ZN00040	A96ZN00040	A96ZN00040
65	A96ZN00043	A96ZN00043	A96ZN00043	A96ZN00043	A96ZN00043

66	A96ZC00013	A96ZC00013	A96ZC00014	A96ZC00014	A96ZC00014
67	A96ZN00032	A96ZN00032	A96ZN00032	A96ZN00032	A96ZN00032
68	A96ZM00002	A96ZM00002	A96ZM00002	A96ZM00002	A96ZM00002
69	S14MT67012	S14MT67013	S14MT67010	S14MT67011	S14MT67018
70	A96ZH00010	A96ZH00010	A96ZH00011	A96ZH00011	A96ZH00011
71	A96ZI00024	A96ZI00024	A96ZI00025	A96ZI00025	A96ZI00025
72	A86ME26027	A86ME26027	A86ME26027	A86ME26027	A86ME26027
73	A86ME26026	A86ME26026	A86ME26026	A86ME26026	A86ME26026
74	A86ME24120	A86ME24120	A86ME24120	A86ME24120	A86ME24120
76	A86ME36006	A86ME36006	A86ME36006	A86ME36006	A86ME36006
81	A96ZH00008	A96ZH00008	A96ZH00009	A96ZH00009	A96ZH00009
83	A96ZI00030	A96ZI00030	S63TR67002	A96ZI00031	A96ZI00031
84	A86ME36007	A86ME36007	A86ME36007	A86ME36007	A86ME36007
86	A96ZN00030	A96ZN00030	A96ZN00030	A96ZN00030	A96ZN00030
93	S42PL00002	S42PL00002	A96ZS00009	A96ZS00009	A96ZS00009
94	A96ZD00003	A96ZD00003	A96ZD00003	A96ZD00003	A96ZD00003
97	A96ZN00053	A96ZN00053	A96ZN00053	A96ZN00053	A96ZN00053
98	A86ME25018	A86ME25018	A86ME25018	A86ME25018	A86ME25018
99	A96ZN00052	A96ZN00052	A96ZN00052	A96ZN00052	A96ZN00052
100	A86ME24122	A86ME24122	A86ME24122	A86ME24122	A86ME24122
101	A96ZN00054	A96ZN00054	A96ZN00054	A96ZN00054	A96ZN00054
105	A96ZV00027	A96ZV00027	A96ZV00027	A96ZV00028	A96ZV00028
106	A96ZN00055	A96ZN00055	A96ZN00055	A96ZN00055	A96ZN00055
116	A96ZF00002	A96ZF00002	A96ZF00002	A96ZF00002	A96ZF00002
121	A88IY00001	A88IY00001	A88IY00002	A88IY00002	A88IY00002
122	A96ZF00021	A96ZF00021	A96ZF00022	A96ZF00022	A96ZF00022
123	A96ZF00013	A96ZF00013	A96ZF00014	A96ZF00014	A96ZF00014
124	A96ZN00084	A96ZN00084	A96ZN00084	A96ZN00084	A96ZN00084

TECHNICAL DATA IF-VS ÷ IR-VS

Model	Power		Voltage	Machine dimensions	Weight	Dough weight	Bowl capacity	Mixing time	Bowl dimension ø x h
	kW	Hp							
IF17VS	0,75	1	230-400	35x66x63	73	12	17	48	32x21
IF22VS	0,75	1	230-400	40x69x63	76	18	22	70	35x21
IF33VS	1,5	2	230-400	44x83x72	106	25	33	100	40x26
IF42VS	1,5	2	230-400	47x85x72	113	38	42	140	45x26
IF53VS	1,5	2	230-400	53x86x72	112	44	53	170	50x26
IR17VS	0,75	1	230-400	37x68x64	91	12	17	48	32x21
IR22VS	0,75	1	230-400	47x72x64	94	22	22	70	35x21
IR33VS	1,5	2	230-400	46x84x73	127	33	33	100	40x26
IR42VS	1,5	2	230-400	49x86x73	131	42	42	140	45x26
IR53VS	1,5	2	230-400	55x87x73	136	53	53	170	50x26